

Name Index No.

School Candidate's signature

Date

232/2

PHYSICS

Paper 2

October /November 2015

Time 2 hours

**KANDARA SUB-COUNTY SECONDARY SCHOOLS
FORM THREE JOINT EXAMINATION**

Kenya Certificate of Secondary Education

PHYSICS

Paper - 232/2

October / November 2015

Time: 2 hours

INSTRUCTIONS TO CANDIDATES

- Write your name and index number in the spaces provided above.
- Sign and write the date of the examination in the spaces provided above.
- This paper consist of two section A and B.
- Answer ALL questions in section A and B in the spaces provided.
- All working must be clearly shown in the spaces provided in this booklet.
- Non-programmable, silent electronic calculators and KNEC mathematical tables may be used.

FOR EXAMINER'S USE ONLY

SECTION	QUESTION	MAXIMUM SCORE	CANDIDATE'S SCORE
A	1 - 13	25	
B	14	13	
	15	10	
	16	13	
	17	11	
	18	08	
TOTAL SCORE		80	

*This paper consists of 8 printed pages
Candidates should check the question paper to ensure that all the
printed pages are printed as indicated and no questions are missing.*

SECTION A (25 marks)

Answer ALL questions in this paper in the spaces provided.

1. An echo sounds produces a pulse and an echo is received from the sea bed after 0.4sec. If the speed of sound in water is 1500m/s calculate the depth of the sea bed. (2 marks)

.....

.....

.....

.....

2. The diagram below shows a ray of light travelling from water to glass. Given that the refractive index of water and glass are 1.33 and 1.5 respectively, find the angle of refraction in glass. (3 marks)

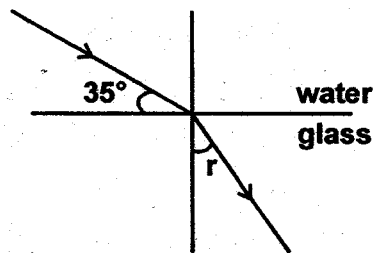

.....

.....

.....

.....

3. The figure below shows cell of internal resistance 0.5Ω connected in series with a 3Ω resistor. Determine the ammeter reading when the switch S is closed. (3 marks)

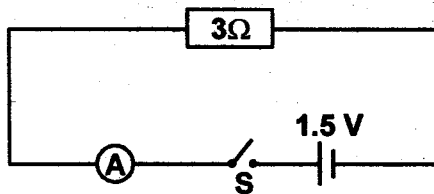

.....

.....

.....

.....

4. A conductor is slowly brought near the cap of a positively charged electroscope. The leaf first collapses and then diverges. State the charge on the conductor. (1 mark)

.....

.....

5. The fig below shows a battery of 6.0V connected in parallel with two capacitors.

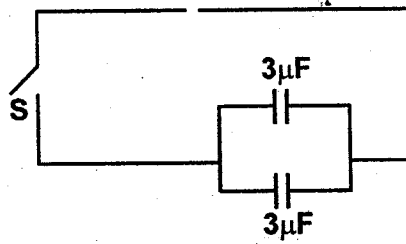

Determine the charge stored in the combined capacitors when the switch (S) is closed. (3 marks)

.....

.....

.....

.....

.....

6. State one defect of a simple cell and explain how it can be minimized. (2 marks)

.....

.....

7. State one application of each of the following. (2 marks)

- i) Convex mirror.....
-
-
- ii) Parabolic reflector.....
-
-

8. The fig. represents a displacement-time graph for a wave.

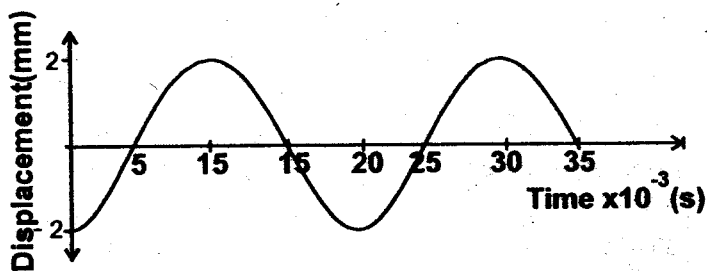

Determine the frequency of the wave. (2 marks)

.....

.....

.....

.....

.....

9. The image formed by a convex mirror is virtual. State two other characteristics of image formed by the convex mirror. (2 marks)

.....
.....
.....

10. State condition to be satisfied for total internal reflection of light to take place (1 mark)

.....
.....

11. using the domain theory, explain how strong heating cause demagnetization. (2 marks)

.....
.....
.....

12. Calculate the speed of yellow colour of light in air if its wavelength is $5.83 \times 10^{-7} \text{m}$ and its frequency is $5.17 \times 10^{14} \text{Hz}$. (1 mark)

.....
.....
.....

13. State the principle on which eclipses are formed. (1 mark)

.....
.....

SECTION B (55 marks)

Answer all the questions in this section in the spaces provided.

14. a) State two characteristics of an image seen below the surface of water (2 marks)

.....
.....

b) The diagram below shows a glass block of refractive index n .

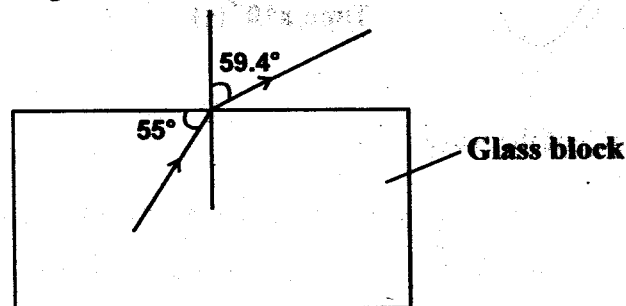

Find:
i) n

(3 marks)

.....
.....
.....

ii) The critical angle for the material

(3 marks)

iii) If the speed of light in air is 3×10^8 m/s, determine the speed of light in that material. (3 marks)

iv) What effect if any does this change of speed have in frequency and wavelength of light? (2 marks)

15. The fig shows a circuit with the ammeter reading 1.5A

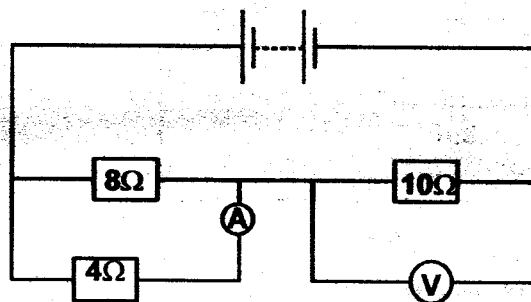

a) Determine the effective resistance.

(2 marks)

b) Determine the voltmeter reading.

(2 marks)

c) Determine how many bulbs each rated 75W 240V can be safely used in a main supply of 240V fitted with a 13A fuse. (3 marks)

d) State two factors that affect the heating effect of an electric current. (2 marks)

.....

.....

.....

e) Give a reason why a fluorescent tube is preferred to a filament, bulb for domestic lighting. (1 mark)

.....

.....

16. a) Draw the electric field pattern in the fig. below. (1 mark)

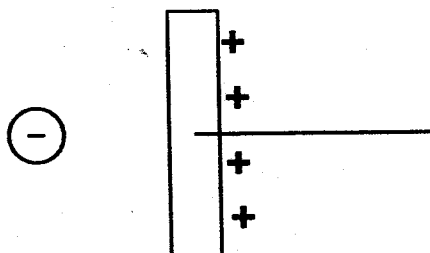

b) The fig. below shows a system of capacitors connected to 100V supply.

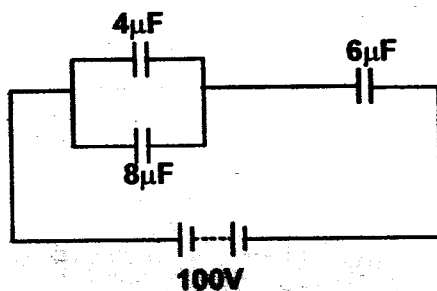

Determine:

i) The effective capacitance of the circuit. (3 marks)

.....

.....

.....

ii) the charge through the 6 μ F capacitor. (3 marks)

.....

.....

.....

iii) the p.d. across the 8 μ f capacitor. (4 marks)

.....

.....

.....

.....

c) State two factors that affect the capacitance of a parallel plate capacitor. (2 marks)

.....
.....
.....

17.a) The diagram below shows a long tank of water in which waves are produced. C is a small cork.

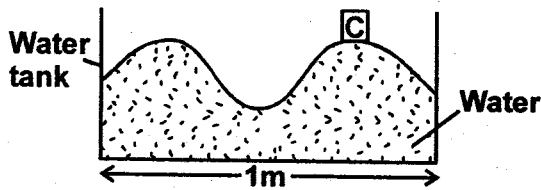

i) Four complete waves are produced every second. What is the period of the waves? (2 marks)

.....
.....
.....

ii) What is the wavelength? (1 mark)

.....
.....

iii) How does the cork move as the wave progresses? Explain your answer. (2 marks)

.....
.....
.....

b) A man is standing 85cm from a cliff face in front and 170m from a cliff at his back. He whistles loudly and hears two echoes one after another.

i) Explain how their can happen. (1 mark)

.....
.....
.....

ii) Calculate the time interval between the two echoes. (Take velocity of sound in air to be 340m/s) (3 marks)

.....
.....
.....
.....

- c) Determine the resultant amplitude for two waves out of phase if one wave has amplitude of 0.5m and the other 3.0m (2 marks)

.....

.....

.....

- 18.a) Define the term electromotive force. (1 mark)

.....

.....

b)

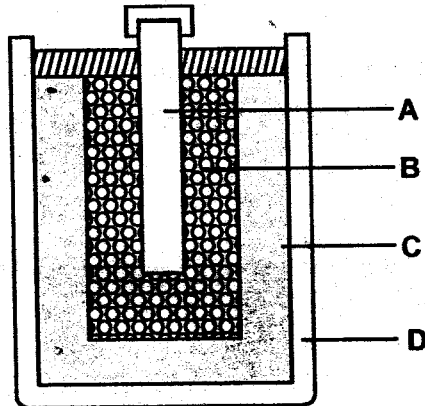

The diagram above shows a dry cell. Name the parts labelled A, B, C and D. (4 marks)

.....

.....

.....

.....

- c) The above cell has two defects. One is at D and the other is at A.

i) Name the defect at A. (1 mark)

.....

ii) How is the defect reduced (1 mark)

.....

iii) Name the defect at D. (1 mark)

.....