







**CHRISTIAN RELIGIOUS EDUCATION**

1.  and  were created by \_\_\_\_\_.
2. Our parents are happy when we \_\_\_\_\_ them.  
(disobey, hate, obey)
3. Joseph had \_\_\_\_\_ brothers.  
(9, 11, 10)
4. It is wrong to receive gifts from \_\_\_\_\_.  
(neighbours, friends, strangers)
5. The Lord called \_\_\_\_\_ by name.  
(Samuel, Eli, Jesus)
6. God gave me  to \_\_\_\_\_ with and \_\_\_\_\_ with.
7.  to \_\_\_\_\_ with.
8. We celebrate the birth of Jesus on \_\_\_\_\_ day.  
(Easter, Christmas, Sunday)
9. Jesus taught his \_\_\_\_\_ the Lord's prayer.  
(children, disciples, people)
10. Most Christians go to \_\_\_\_\_ on Sunday. (market, mosque, church)
11. The \_\_\_\_\_ of Jesus was called Mary. (brother, father, mother)

12. God made all \_\_\_\_\_.
13. \_\_\_\_\_ did not have a child. She prayed to God and her prayers were heard.  
(Penninah, Mary, Hannah)
14. When we \_\_\_\_\_, we are talking to God.
15. The \_\_\_\_\_ is the holy book for Christians.
16. I am a child of \_\_\_\_\_.

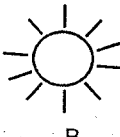
**Circle those that were created by God.**

17.  18.   

A B C D

19. Jesus had \_\_\_\_\_ disciples.  
(8, 10, 12)
20. \_\_\_\_\_ is one gift given by the wise men.

**Draw the following gifts from God.**

21. Hands	22. Head
-----------	----------

23. Jesus was crucified on the \_\_\_\_\_  
(tree, house, cross)
24. When somebody is baptised he gets a new \_\_\_\_\_  
(colour, name, shape)
25. God created the world in \_\_\_\_\_ days. (5, 6, 7)
26. When baby Jesus was born he was laid on a \_\_\_\_\_  
(bed, manger, table)
27. Samuel stayed in the temple with \_\_\_\_\_.
28. The Bible is divided into \_\_\_\_\_ parts. (1, 2, 3)
29. Jesus died to save us from our \_\_\_\_\_.
30. Ten lepers were healed. How many came to say thank you? (5, 1, 4)
31. Joseph and Mary lived in \_\_\_\_\_  
(Nazareth, Bethlehem, Jericho)
32. When we worship we show our \_\_\_\_\_ to God.  
(hate, love, body)
33. The National Anthem is a \_\_\_\_\_ for our country.  
(song, prayer, hymn)
34. Our parents give us \_\_\_\_\_ and  
35. \_\_\_\_\_

36. Pupils who go to same school are \_\_\_\_\_  
(classmates, friends, schoolmates)
37. \_\_\_\_\_ loves little children.  
(God, Satan, Teacher)
38. The first people created by God were \_\_\_\_\_ and  
39. \_\_\_\_\_
40. Our \_\_\_\_\_ take us to hospital when we are sick.  
(parents, teachers, strangers)

**Write 'yes' or 'No' for question no. 41 - 44.**

41. Children love their parents. \_\_\_\_\_
42. Samuel was the son of Abraham.  
\_\_\_\_\_
43. God wants us to be thieves. \_\_\_\_\_
44. A family is a gift from God. \_\_\_\_\_



45. We know that this is a church because it has a \_\_\_\_\_.  
(door, cross, window)

46. Jesus healed a blind man called \_\_\_\_\_  
(Joseph, Judas, Bartimaues)
47. When I am given something I should say \_\_\_\_\_.
48. The wise men were led by the \_\_\_\_\_.  
(moon, sun, stars)
49. We use our ears to \_\_\_\_\_ and our hands to 50. \_\_\_\_\_.



13. Muslims fast during the month of \_\_\_\_\_  
(Shaaban, Ramadhan, Shawwal, Rajab)

14. The celebration for Muslims is \_\_\_\_\_  
(Idd, Christian, Easter, Diwal)

**Fill in the blank spaces**

(Name the following gifts of Allah (S.W))

15. Isl \_\_\_\_\_ m

16. Q \_\_\_\_\_ bla

17. Qu \_\_\_\_\_ n

18. It is good to \_\_\_\_\_ the poor. (laugh, help, hate, blame)

19. Who created everything? \_\_\_\_\_ (Allah, Shietwan, Angels, Prophets)

20. \_\_\_\_\_ was given to prophet Issa. (Injil, Taurat, Quran, Zabour)

**Name the following gifts of Allah**

21.  \_\_\_\_\_

22.  \_\_\_\_\_

23.  \_\_\_\_\_

24. Muslims believe in \_\_\_\_\_ pillars of Islam (6, 5, 10, 2)

25. Abdul-Mutualib was the \_\_\_\_\_ of prophet Muhammad (S.A.W)  
(father, uncle, grand-father, friend)

26. The first pillar of Islam is \_\_\_\_\_ (Shahada, Swalah, Zakah, Swaum)

27. The shahada is also called the \_\_\_\_\_. (Adhan, Kalima, Iqamah, Swalah)

28. Dhur prayer has \_\_\_\_\_ Rakaas (4, 10, 3, 2)

29. I perform \_\_\_\_\_ before praying (Udhu, Itkaaf, Istanjil, Ghysl)

30. We should \_\_\_\_\_ our teachers. (hate, respect, disobey, annoy)

## Read the words

- |                |                 |
|----------------|-----------------|
| 1. breakfast   | 11. teeth       |
| 2. compound    | 12. toe         |
| 3. home work   | 13. goats       |
| 4. register    | 14. brother     |
| 5. grandmother | 15. washing     |
| 6. office      | 16. duster      |
| 7. rubbish     | 17. time        |
| 8. week        | 18. bottle      |
| 9. clock       | 19. headteacher |
| 10. Saturday   | 20. parents     |

## Read the following sentences

21. I have my birthday party today.
22. These are trees.
23. The broom is in the box.
24. The dog is barking.
25. Where is the yellow dress?

**Andika jina la picha**

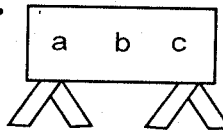
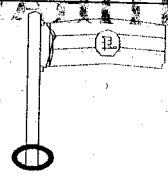
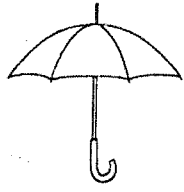
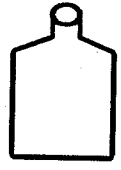
<p>1. </p> <p>_____</p>	<p>2. </p> <p>_____</p>
<p>3. </p> <p>_____</p>	<p>4. </p> <p>_____</p>

**Unda maneno ukitumia mianza hii**

- 5. sho - \_\_\_\_\_
- 6. ji - \_\_\_\_\_
- 7. nya - \_\_\_\_\_
- 8. de - \_\_\_\_\_

**Jibu salamu**

- 9. Habari - \_\_\_\_\_
- 10. Shikamoo - \_\_\_\_\_

**Jaza pengo**

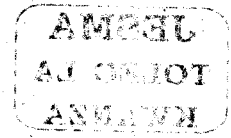

11. ml \_\_\_ ng \_\_\_

12. ag \_\_\_ z \_\_\_ t \_\_\_

13. \_\_\_ mb \_\_\_

**Andika kwa maneno au tarakimu**



14. therathini na nane - \_\_\_\_\_

15. 40 - \_\_\_\_\_

16. 56 - \_\_\_\_\_

17. sabini na tisa - \_\_\_\_\_

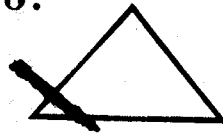
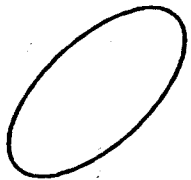
**Andika majina ya maumbo**

<p>18. </p> <p>_____</p>	<p>19. </p> <p>_____</p>
<p>20. </p> <p>_____</p>	

**Neno lipi tofauti?**

21. nyumba, nyuzi, nyuki, chuki  
\_\_\_\_\_

22. siku, sikio, kiatu, sitini  
\_\_\_\_\_

**Andika maneno vizuri**

23. bukita - \_\_\_\_\_

24. sirafa - \_\_\_\_\_

25. sharidi - \_\_\_\_\_

**Andika majina ya sehemu za mwili**

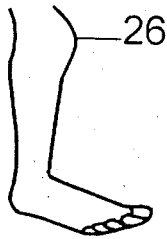

27.



28.

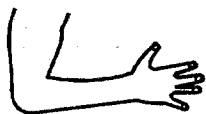

**Tegua vitendawili**  
(macho, chupa, yai, kalamu, kitanda)

29. Mama nieleke -  
\_\_\_\_\_

30. Popoo mbili zavuka mto -  
\_\_\_\_\_

31. Bubu anayesema -  
\_\_\_\_\_

**Chagua jina sahihi la mavazi haya**

(kaptura, sketi, chepeo, rinda, shimizi, tai)

32.



33.

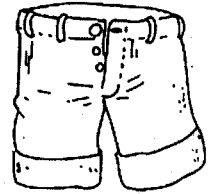

34.



35. Jina jingine la kamisi ni  
\_\_\_\_\_

### Chagua jibu sahihi

(nyekundu, samawati, nyeusi, nyeupe, kijani)

36. Majani ya miti ni rangi gani? \_\_\_\_\_

37. Rangi ya maziwa ni \_\_\_\_\_

38. Damu ni rangi gani? \_\_\_\_\_

39. Nywele na makaa ni rangi gani? \_\_\_\_\_

### Andika kwa wingi

40. mkebe - \_\_\_\_\_

41. mkulima - \_\_\_\_\_

42. kijiko - \_\_\_\_\_

### Chagua jibu sahihi

43. Ndama ni mtoto wa \_\_\_\_\_

(paka, ng'ombe)

44. Mnyama mnono zaidi ni \_\_\_\_\_

(punda, kuku, nguruwe)

45. Ndege mkubwa zaidi wa nyumbani ni \_\_\_\_\_.  
(kuku, njiwa, batamzinga)

46. Mbuji ana miguu \_\_\_\_\_.  
(miwili, minne, mbili)

### Tazama ndege huyu ili ujibu maswali

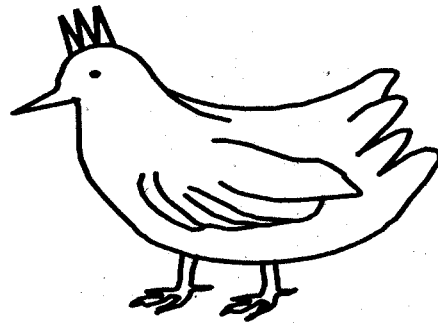

47. Ndege huyu huitwaje?  
(kasuku, bata, kuku)

48. Anaishi wapi? \_\_\_\_\_  
(nyumbani, majini, msituni)

49. Yeye hutaga \_\_\_\_\_.  
(nyama, vifaranga, mayai)

50. \_\_\_\_\_ ni mtoto wa kuku.  
(Kifaranga, Kiyoyo, Kipusi)



## Soma maneno haya vizuri

- |              |              |
|--------------|--------------|
| 1. kiberiti  | 11. patipati |
| 2. nanasi    | 12. bata     |
| 3. mwezi     | 13. chumvi   |
| 4. duaradufu | 14. runinga  |
| 5. wembe     | 15. mapaja   |
| 6. mswaki    | 16. Alhamisi |
| 7. soksi     | 17. mchana   |
| 8. papai     | 18. penseli  |
| 9. nguruwe   | 19. mto      |
| 10. suruali  | 20. kasuku   |

## Soma sentensi zifuatazo

21. Meza hii ni nzuri.
22. Dada amevaa rinda.
23. Nipe kalamu yangu.
24. Shangazi amefika.
25. Kuku ana manyoya.

1. We eat the stem of \_\_\_\_\_ plant. (maize, sugarcane, carrot)

2. Plants are held in the ground by the \_\_\_\_\_ (flower, fruit, roots)

3. We wash our body with \_\_\_\_\_ and 4. \_\_\_\_\_.

5. Always keep your finger nails short and \_\_\_\_\_.

6.  This is called a \_\_\_\_\_

7. In most plants it is \_\_\_\_\_ in colour.

8. People drink a lot of water in a \_\_\_\_\_ day.

9. Nose is to \_\_\_\_\_ as eyes is to see.

10. Plants we eat are called \_\_\_\_\_ plants. (raw, edible, good)

11. A flower of a plant changes into a \_\_\_\_\_. (stem, leaf, fruit)

12. Dirty hair can keep \_\_\_\_\_. (mosquitoes, jiggers, lice)

13. We use a  to clean our nose.

(handkerchief, towel, cloth)

14. Children fly \_\_\_\_\_ when the weather is



15. A \_\_\_\_\_ has a long neck.

16. We get \_\_\_\_\_ and 17. \_\_\_\_\_ from a bee.

18. We get water from the



19. A fly has \_\_\_\_\_ legs. (6,7,8)

20. We grind \_\_\_\_\_ to get maize flour. (wheat, rice, maize)

21. Another name for sukumawiki is (kales, spinach, corriander)

22. When there are dark \_\_\_\_\_ in the sky, it is likely going to \_\_\_\_\_. 

**Match animals below with their meat.**

- |           |         |
|-----------|---------|
| 23. Cow   | Mutton  |
| 24. Pig   | Chicken |
| 25. Sheep | Beef    |
| 26. Calf  | Pork    |
| 27. Hen   | Veal    |

28. The eye has \_\_\_\_\_ colours.  
(1, 2, 3)

29. \_\_\_\_\_ is moving air.  
(Sky, Wind, Rain)

30. We get food from plants and \_\_\_\_\_.  
(cows, maize, animals)

31.  There is \_\_\_\_\_  
in the balloon.  
(air, wind, water)

32. People who live near lakes and seas eat a lot of \_\_\_\_\_.  
(food, fish, meat)

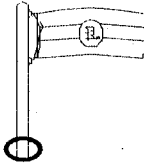
33. A  waves when the weather is \_\_\_\_\_.  
(cloudy, sunny, windy)

34. A bird has \_\_\_\_\_ legs.  
(2, 3, 4)

35. When there is no toothpaste we use  water with \_\_\_\_\_.  
(milk, salt, sugar)

36. In the diagram below, the part marked X is the \_\_\_\_\_.  
(head, wattle, feather)

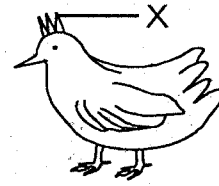

37. People wear heavy jackets when the weather is \_\_\_\_\_.  
(cloudy, cold, hot)

38. A \_\_\_\_\_ is an animal with no legs.

Name the parts of the arm below.

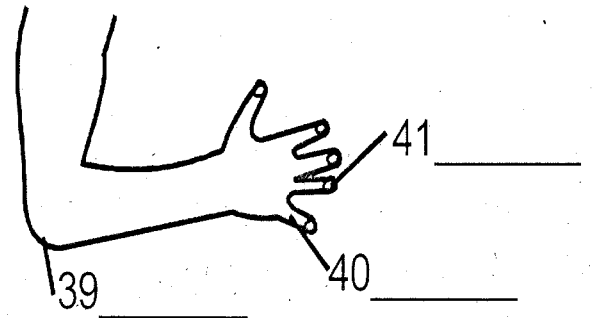

42. Dirty feet can get \_\_\_\_\_.  
(flies, jiggers, lice)

43. We breathe in air through our \_\_\_\_\_.  
(mouth, tongue, nose)

44. The main source of water is the \_\_\_\_\_.  
(river, rain, sea)

Name the parts of the fish.

Use these words

(scales, gills, fins, tail)

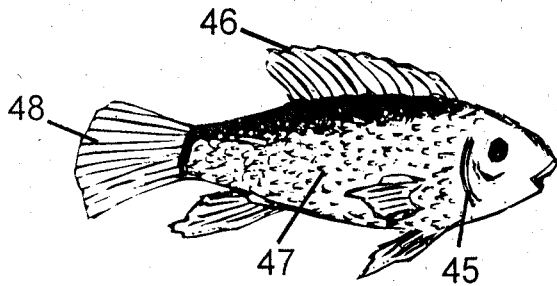

45. \_\_\_\_\_

46. \_\_\_\_\_

47. \_\_\_\_\_

48. \_\_\_\_\_

49. Name one fruit with many seeds. \_\_\_\_\_

50. A \_\_\_\_\_ is a vegetable.  
(carrot, mango, bean)

Make words with these sounds

- 1. Th
- 2. Po
- 3. Cr

What colour are these?

- 4. Teeth -
- 5. Ripe bananas -
- 6. Sky -

Use "a" or "an"

- 7. I have eaten        orange.
- 8. Give me        rubber.

Name these pictures

9.                      

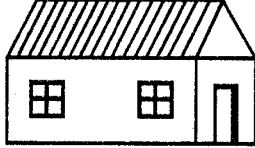
10.                      

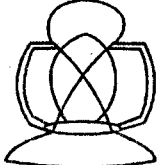
11.                      

One

Many

- 12. fox
- 13. dress
- 14. watch

Answer the questions

- 15. The eighth month of the year is                     .
- 16. The month with the shortest name is                     .
- 17. November, December,                     , February
- 18. Write one month which ends in 'e'                     .

Write well

- 19. astr -
- 20. lowerf -
- 21. erte -

Choose the correct word

22. Brother is to sister as uncle is to \_\_\_\_\_.

23. Father is to mother as grandmother is to \_\_\_\_\_.

What is the time?

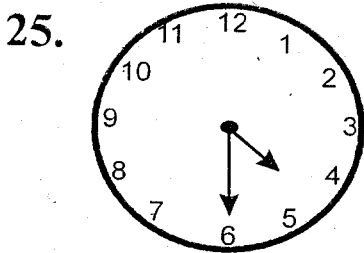
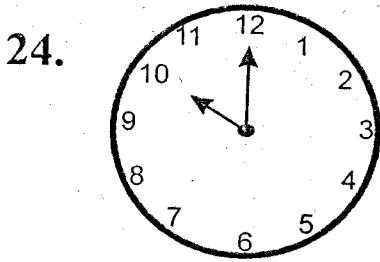

Add 'ing' to the words

26. Use - \_\_\_\_\_

27. Bleed - \_\_\_\_\_

28. Dive - \_\_\_\_\_

Today

Yesterday

29. Kick \_\_\_\_\_

30. Pull \_\_\_\_\_

31. Cook \_\_\_\_\_

Fill in the missing letters

32. Tu \_\_\_sd\_\_\_y

33. A \_\_\_g\_\_\_st

Use "is" or "are"

34. Mary and Peter \_\_\_\_\_ good children.

35. My big doll \_\_\_\_\_ lost.

Name the pictures

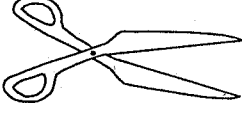
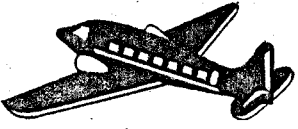
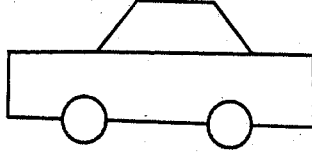
<p>36. </p> <p>_____</p>	<p>37. </p> <p>_____</p>
<p>38. </p> <p>_____</p>	

**Answer the questions**

39. If today is Friday, tomorrow will be \_\_\_\_\_.

40. The fifth day of the week is \_\_\_\_\_.

41. The baby of a goat is called \_\_\_\_\_.

42. The mother of a tadpole is the \_\_\_\_\_.

**Write in words or figures**

43. 38 - \_\_\_\_\_

44. 12 - \_\_\_\_\_

45. Sixty nine - \_\_\_\_\_

**Write five sentences about "A hen"**

46. \_\_\_\_\_

47. \_\_\_\_\_

48. \_\_\_\_\_

49. \_\_\_\_\_

50. \_\_\_\_\_

1. 66, 67, 68, 69

2. 8,     ,     , 5,     , 3

3. 10,     , 30,     , 50,     

4.  $8 - \underline{\quad} = 2$

5.  $3 + 5 + \underline{\quad} = 12$

6.   
=      tens      ones =     

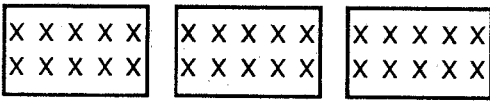
7.   
=      tens      ones =     

8.  $98 = \underline{\quad}$  tens and      ones

9. Three cars have            wheels.

10.   
     +      +      =     

11.  $70 + 2 = \underline{\quad}$

12.  $\begin{array}{r} 9 \\ + 9 \\ \hline \end{array}$

13.  $\begin{array}{r} 11 \\ - 3 \\ \hline \end{array}$

14.  $\begin{array}{r} 7 \\ + 4 \\ \hline \end{array}$

15.  $\begin{array}{r} 73 \\ - 1 \\ \hline \end{array}$

16.  $\begin{array}{r} 43 \\ + 14 \\ \hline \end{array}$

17. Romba had 12 books. Jane gave her 4 books. How many books did Romba have?           

**Write the numbers in words.**

18.  $19 = \underline{\hspace{2cm}}$

19.  $32 = \underline{\hspace{2cm}}$



Name the shapes.

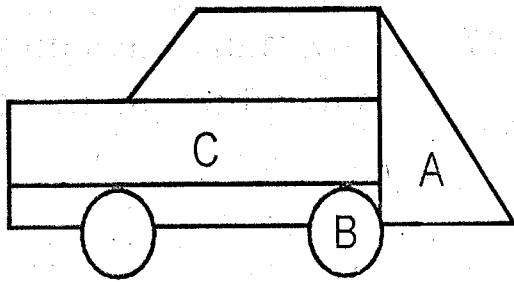

20. A \_\_\_\_\_

21. B \_\_\_\_\_

22. C \_\_\_\_\_

23.	5	24.	4
	+		+
	0		2
	3		3
	_____		_____
	_____		_____

Count and write.

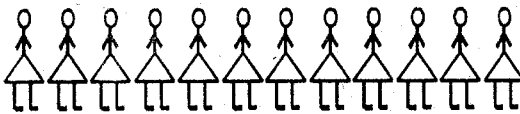
25.   
= \_\_\_\_\_

26.   
= \_\_\_\_\_

27. 64 sheep take away 3 sheep  
= \_\_\_\_\_ sheep.

28.  $12 - 7 =$  \_\_\_\_\_

29.  $62 + 33 =$  \_\_\_\_\_

30.  $21 + 13 =$  \_\_\_\_\_

31.  $17 + 2 =$  \_\_\_\_\_

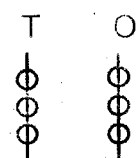
32.  \_\_\_\_\_ = \_\_\_\_\_

33. Which holds more?

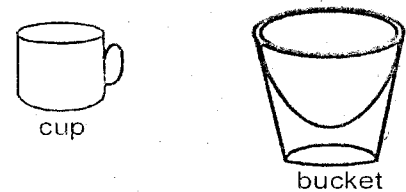

34. 8 take away 5 = \_\_\_\_\_

35. Which is shorter?

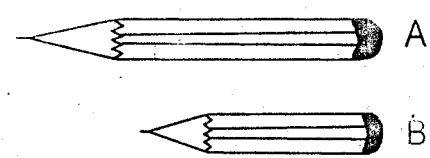

36.  $5+2+7=$  \_\_\_\_\_

**Write the missing number.**

37.  $\square + \square = 14$

38.  $4 + \square = 18$

39.  $6 + \square = 12$

40.  $\square + 7 = 15$

41. Which is lighter?

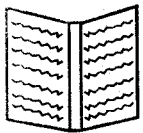

book

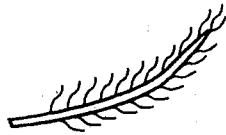

feather

\_\_\_\_\_

42.  $32+7 =$  \_\_\_\_\_

43.  $6+9 =$  \_\_\_\_\_

44.  $3 - 3 =$  \_\_\_\_\_

45. How many oranges are there in the baskets?

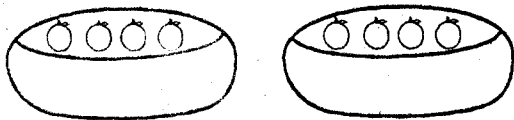

$=$  \_\_\_\_\_

46. This is a  $\int$  \_\_\_\_\_ line.

47. How many days do you go to school in a week?

\_\_\_\_\_

48.  $6 =$  \_\_\_\_\_ tens \_\_\_\_\_ ones

49. 3 hens have \_\_\_\_\_ legs.

50. Circle the numbers more than 8.

8, 9, 6, 10, 5, 12, 4

1.  This house belongs to the \_\_\_\_\_ people.  
(Luhya, Maasai, Kikuyu)

2. The above house is made of sticks and \_\_\_\_\_.  
(stones, bricks, mud)

3. Which room do you find mattresses, sheets and blankets?  
\_\_\_\_\_  
(bedroom, sitting room, bathroom)

4. A house keeps us safe from \_\_\_\_\_.

5. Name one animal found at home.  
\_\_\_\_\_.

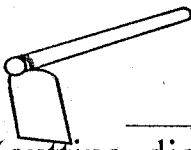
6.  This is a jembe. It is used for \_\_\_\_\_.  
(cutting, digging, cooking)

7. \_\_\_\_\_ is a harmful animal found in the kitchen.  
(lice, bee, cockroach)

8. Long time ago grains like beans, maize and others were kept in the \_\_\_\_\_.  
(house, kitchen, granary)

9. \_\_\_\_\_ is a male parent.

10. The mother to my father is my \_\_\_\_\_.  
(aunt, grandmother, grandfather)

11. We use  to \_\_\_\_\_.  
the floor.

12. A \_\_\_\_\_ is a family celebration.  
(birthday, funeral, holiday)

13. Children have right to \_\_\_\_\_.

14. Our school \_\_\_\_\_ helps us to look different from children in other schools.  
(clothes, books, uniform)

15. A family which is made up of father, mother, grandparents, uncles, aunts and cousins is called an \_\_\_\_\_ family.  
(single, extended, nuclear)

16. \_\_\_\_\_ is the head of a school.  
(headboy, headteacher, headmistress)

17. My country is called \_\_\_\_\_.

18.  This is called a \_\_\_\_\_  
 (pot, bottle, guard)  
 We can put 19. \_\_\_\_\_  
 inside. (milk, ink, soil).

20. Animals that live at home are called \_\_\_\_\_ animals.

21. Sheep give us \_\_\_\_\_  
 and 22. \_\_\_\_\_.

23. \_\_\_\_\_ is the song we sing while raising the  
 (Lullaby, Chorus, National Anthem)

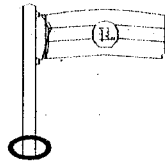

24. Sick children are taken to the \_\_\_\_\_.

25. We should not play with \_\_\_\_\_.  
 It can cut us.  
 (needle, panga, fire)

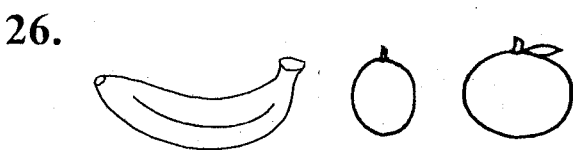

These are examples of \_\_\_\_\_.

27. \_\_\_\_\_ is an animal that helps us to carry loads.  
 (Cat, Donkey, Goat)

28. My school is called \_\_\_\_\_.

29. A block of flats is called \_\_\_\_\_ in Kiswahili.  
 (ghorofa, nyumba, mabati)

30. Draw and name one building material.

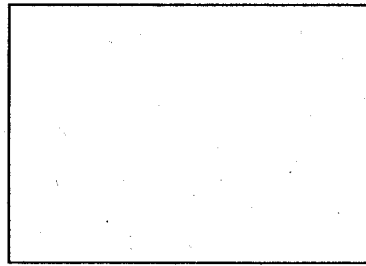

31. Long ago people lived in \_\_\_\_\_.  
 (houses, caves, sheds)

32. A village home has a \_\_\_\_\_.  
 (toilet, bus, latrine)

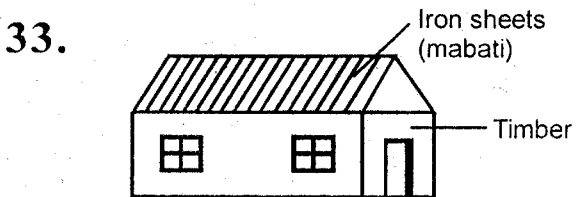

This is a \_\_\_\_\_ house.  
 (traditional, permanent, semi-permanent)

34. A \_\_\_\_\_ grows food in his farm.

35. We cut grass to keep away \_\_\_\_\_.  
 (lions, snakes, dogs)

36. Every home must have a \_\_\_\_\_  
(car, T.V, toilet)

37. A good child should \_\_\_\_\_  
the elders.  
(obey, hate, abuse)

38. A cow gives us meat called \_\_\_\_\_  
(pork, mutton, beef)

39. We buy fruits, vegetables and  
other food from the \_\_\_\_\_.

40. The Hindus celebrate \_\_\_\_\_ while the  
Muslims celebrate

41. \_\_\_\_\_  
(Idd-ul-fitr, Christmas, Diwali)

42. Food and water make us grow \_\_\_\_\_  
(dull, weak, strong)

43.  This is a \_\_\_\_\_.  
The roof is made of \_\_\_\_\_

44. \_\_\_\_\_

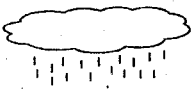
45. When the weather is   
we carry \_\_\_\_\_.  
(books, umbrella, gumboots)

46. \_\_\_\_\_ cooks food for  
the family.  
(father, aunt, mother)

47. The \_\_\_\_\_ of a cow  
can be used to make belts.  
(skin, meat, bones)

48. Animals found in the forest are  
called \_\_\_\_\_ animals.

49. Name one thing found in the  
sitting room?  
\_\_\_\_\_

50. Long ago people wore clothes  
made of \_\_\_\_\_.

STANDARD TWO 2015  
MARKING SCHEME

MATHS	ENGLISH	KISWAHILI	SCIENCE	SOCIAL	C.R.E	I.R.E
1. 64, 65, 66, 67, 68, 69	1. Any correct answer	1. ubao	1. Sugarcane	1. Maasai	1. God	1. moon
2. 8, 7, 6, 5, 4, 3	2. Any correct answer	2. bendera	2. roots	2. mud	2. obey	2. star
3. 10, 20, 30, 40, 50, 60	3. Any correct answer	3. mwavuli	3. soap	3. bedroom	3. 11	3. sun
4. 6	4. White	4. chupa	4. water	4. rain, wild animals, thieves, wind	4. strangers	4. tree
5. 4	5. Yellow	5. shoka	5. clean	5. Cow, goat, sheep, donkey, cat	5. Samuel	5. Breath
6. 2 tens 5 ones = 25	6. Blue	6. jicho, jino, jibu	6. leaf	6. digging	6. see	6. Read
7. 3 tens 0 ones = 30	7. an	7. nyanya, nyasi, nyati	7. green	7. cockroach	7. walk	7. Hear
8. 9 tens 8 ones = 98	8. a	8. debe	8. hot, sunny	8. granary	8. christmas	8. Al-fatiha
9. 12 wheels	9. Eyes	9. Njema/Nzuri	9. smell	9. father	9. disciples	9. Fatiha
10. 4 + 2 + 3 = 9	10. House	10. Marahaba	10. edible	10. grandmother	10. church	10. Iman
11. 72	11. Lamp	11. mlang'o	11. fruit	11. sweep, clean	11. mother	11. Jibril
12. 18	12. Foxes	12. gazeti	12. lice	12. birthday	12. things	12. Amina
13. 8	13. Dresses	13. embe, ombi	13. handkerchief	13. education, food, medical care	13. Hannah	13. Ramadhan
14. 11	14. Watches	14. 38	14. kites	14. uniform	14. prayer	14. Idd
15. 72	15. August	15. arubaini	15. giraffe	15. extended	15. Bible	15. Islam
16. 57	16. May	16. hamsini na sita	16. Honey	16. headteacher	16. God	16. Qibla
17. 12 + 4 = 16 books	17. January	17. 79	17. Wax	17. Kenya	17. Sun	17. Quran
18. Nineteen	18. June	18. pembetatu	18. rain	18. guard	18. Tree	18. help
19. Thirty two	19. Star	19. duaradufu	19. 6	19. milk	19. 12	19. Allah
20. A - Triangle	20. Flower	20. mstatili	20. maize	20. domestic	20. gold, myrrh, frankincense	20. Injil
21. B - Circle	21. Tree	21. chuki	21. kales	21. wool	21. drawing	21. eye
22. C - Rectangle	22. Aunt	22. kiatu	22. rain	22. meat or mutton	22. cross	22. hand
23. 8	23. Grandfather	23. kitabu	23. beef	23. National Anthem	23. name	23. leg
24. 9	24. Ten o'clock	24. farasi	24. pork	24. hospita	24. 6	24. 5
25. 12 girls	25. Three thirty o'clock	25. dirisha	25. mutton	25. panga	25. manger	25. grandfather
26. 14 trees	26. Using	26. goti	26. veal	26. fruits	26. Eli	26. Shahada
27. 61 days	27. Bleeding	27. jicho	27. chicken	27. donkey	27. 2	27. Kalirita
28. 5 sheep	28. Diving	28. mkono	28. 2	28. ghorofa	28. 2	28. 4
29. 95	29. Kicked	29. kitanda	29. wind	29. drawing	29. sins	29. udhu
30. 34	30. Pulled	30. macho	30. animals	30. caves	30. 1	30. respect
31. 19	31. Cooked	31. kalamu	31. air	31. latrine	31. Nazareth	
32. 3 tens 3 ones = 33	32. Tuesday	32. rinda	32. fish	32. semi permanent	32. love	
33. Bucket	33. August	33. kaptura	33. windy	33. farmer	33. prayer	
34. 3	34. are	34. chapeo	34. 2	34. snakes	34. food	
35. B	35. is	35. shimizi	35. salt	35. toilet	35. clothes	
36. 14	36. Scissors	36. kijani	36. wattle	36. obey	36. schoolmates	
37. 10 + 4 = 14	37. Aeroplane	37. nyeupe	37. cold	37. beef	37. God	
38. 4	38. Car	38. nyekundu	38. snake, fish, snail, slug, earth worm	38. market, supermarket	38. Adam	
39. 6	39. Saturday	39. nyeusi	39. Elbow	40. Dirwali	39. Eve	
40. 8	40. Thursday	40. mikebe	40. finger	41. Idul-fitir	40. parents	
41. Feather	41. Kid	41. wakulima	41. nail	42. strong	41. Yes	
42. 39	42. Frog	42. vijiko	42. jiggers	43. hut	42. No	
43. 15	43. Thirty Eight	43. ng'ombe	43. nose	44. grass	43. No	
44. 0	44. Twelve	44. nguruwe	44. rain	45. umbrella	44. Yes	
45. 8 oranges	45. 69	45. batamzinga	44. rain	46. mother	45. cross	
46. curved	46. Optional	46. minne	45. gills	47. skin	46. Bartimaues	
47. 5 days	47. 50.	47. kuku	46. fins	48. wild	47. Thank you	
48. 0 tens 6 ones		48. nyumbani	47. scales	49. TV, sofaset, table chairs e.t.c.	48. stars	
49. 6 legs		49. mayai	48. tail	50. grass, leaves, skin	49. hear	
50. 9, 10, 12		50. kifaranga	49. pawpaw, watermelon, orange, lemon, guava etc.		50. clap, eat, write	
			50. carrot			