

Mathematics Activities

Grade 1



NAME SCHOOL DATE

Count and write.

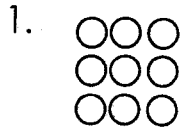

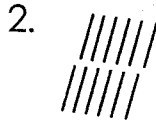

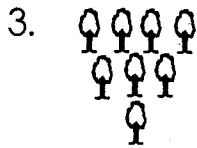

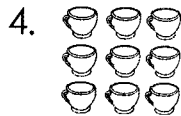

Fill in the place value chart.

	tens	ones
5. 43	_____	_____
6. 44	_____	_____
7. 92	_____	_____
8. 63	_____	_____
9. 21	_____	_____

Add:-

10. $11 + 8 =$

11. $20 + 3 =$

12. $14 + 4 =$

13. $16 + 6 =$

14. $10 + 20 =$

Subtract.

15. $20 - 10 =$

16. $15 - 5 =$

17. $16 - 6 =$

18. $14 - 3 =$

19. $19 - 4 =$

Write in words.

20. 4 _____

21. 3 _____

22. 10 _____

23. 20 _____

24. 6 _____

25. 7 _____

Fill in the missing numbers.

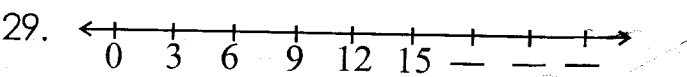
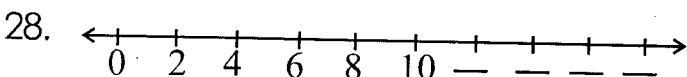
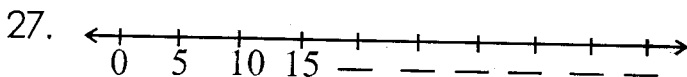
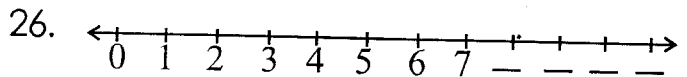

Which one is bigger?

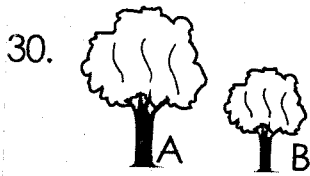



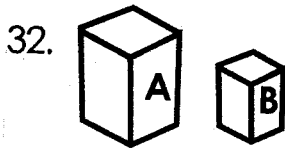

Write in words.

32. 20 _____

33. 15 _____

34. 10 _____

35. 6 _____

36. 7 _____

37. 8 _____

38. 9 _____

Write either straight line or curved line.

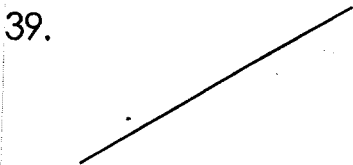



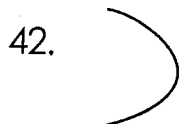

Draw.

43. 20 dots

44. 3 triangles

Which one is longer?

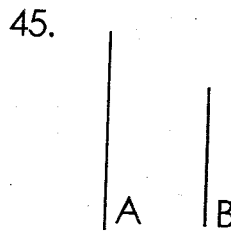

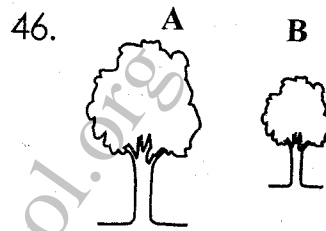

Who is taller?

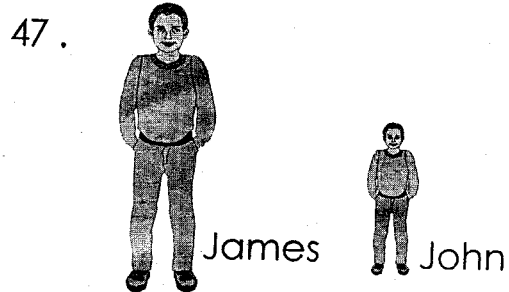

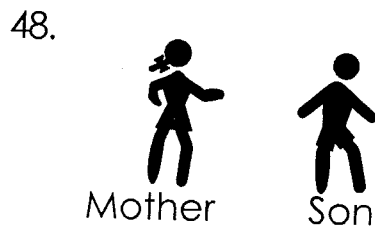

49. Two boys have _____ eyes.

50. Eight cows have _____ horns.

NAME SCHOOL DATE.....

Hygiene and nutrition

Name the following foods we eat.

1.

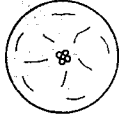

2.

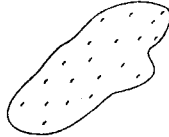

3.



4.



5.

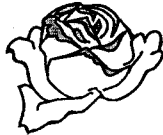

6.



(kales, cabbage, potato, apple sugarcane, orange)

7.

I have _____ senses.
(3, 4, 5)

8.

_____ is a source of water.
(drinking, washing, rain)

9.

We use _____ to dry clothes.
(rain, sun, clouds)

10.

A _____ is used to store water at home.
(pot, bag, plate)

11.

Plants give us _____
(dirt, food, dust)

12.

We should keep our nails _____ and 13 _____
(short, long, clean, dirty)

13.

We should not share _____
(books, toothbrush, beddings)

14. We boil water to kill _____
(sugar, germs)

15. Every home should have a _____
(toilet, kitchen, bed)

16. A bicycle has _____ wheels.
(2, 1, 4)

17. Moon gives us light at _____
(night, day, morning)

18. Cows give us _____
(milk, fur, blood)

Name the body parts.

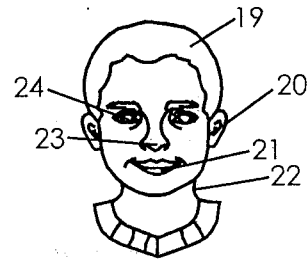

19. _____

20. _____

21. _____

22. _____

23. _____

24. _____

25. This is a _____



(flower, plant)

26. When it is raining people carry

umbrellas, shoes, shirts

27. I see with my _____ and hear with my 28. _____

(eyes, ears, nose)

28. The best soil for modeling is _____

(sand, clay, loam)

29. People walk using their _____

(hands, legs)

30. We can climb _____ trees.

(small, big, all)

31. People remove coats when the weather is _____

(rainy, sunny, windy)

Match

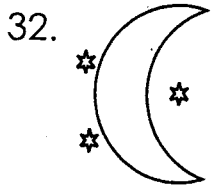

During the day

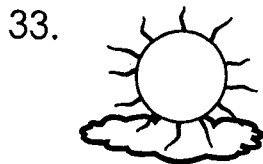

At night

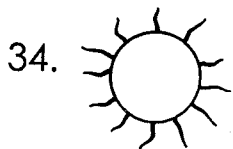

In the morning

35. _____ can be eaten before cooking. **(mangoes, maize)**

36. We use a _____ to clean our teeth. **(broom, toothbrush)**

37. After visiting the toilet we should wash our _____ **(hands, legs, face)**

Name these fruits.

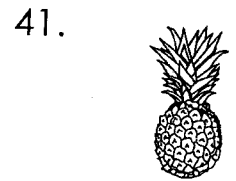
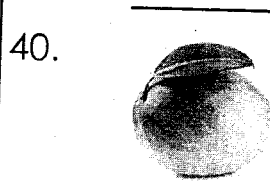

(pineapple, avocado, mango, banana)

Name these utensils.

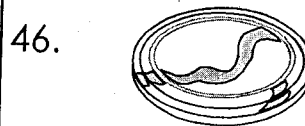

(spoon, jug, cup, plate, bowl, knife)

48. Small babies feed on _____ **(milk, ugali, bread)**

49. We swallow medicine with _____ **(tea, soup, water)**

50. Food we eat in the morning is called _____ **(supper, lunch, breakfast)**

Tusome Early Literacy Programme

Grade 1

Muhula wa kwanza

Kiswahili

Jina: _____

Shule: _____ Darasa: _____

Sehemu ya A: Imla.

Andika maneno mwalimu atakayoyasema.

1. _____
2. _____
3. _____
4. _____
5. _____
6. _____
7. _____
8. _____
9. _____
10. _____

13. ka _____

14. nya _____

15. da _____

16. fa _____

17. ra _____

18. m _____

Sehemu ya B: Silabi

Andika maneno kutokana na silabi hizi.

11. ba _____

12. du _____

Sehemu ya C: Sarufi

Andika kwa herufi kubwa.

19. tumbo - _____

20. chakula - _____

21. urembo - _____

22. chini - _____

23. zima - _____
 24. zama - _____
 25. kiti - _____

Sehemu ya D: Msamiati
Andika majina ya picha hizi.

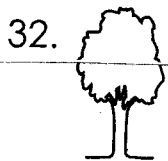
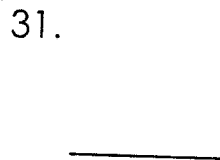

Sehemu ya E: Msamiati
Linganisha siku na nambari

- | | |
|--------------|---|
| 33. Jumatatu | 5 |
| 34. Jumanne | 6 |
| 35. Jumatano | 7 |
| 36. Alhamisi | 1 |
| 37. Ijumaa | 2 |
| 38. Jumamosi | 3 |
| 39. Jumapili | 4 |

Sehemu ya F: Sarufi

Andika kwa wingi

40. Kikombe - _____
 41. Mfuko - _____
 42. Mwalimu - _____
 43. Mtoto - _____
 44. Kitanda - _____
 45. Kiti - _____

Sehemu ya G: Ufahamu

Soma hadithi kisha ujibu maswali.

Nyamari aliishi kijijini. Watu wabaya wenye nyororo wakaja na kumteka nyara Nyamari. Nyamari alikariri shairi la nyuki. Nyuki wakaja na kuwauma wale watu wabaya. Wakatoroka huku wakilia.

46. Nyamari aliishi wapi? _____
 47. Watu wabaya walimfanya nini Nyamari? _____
 48. Nyamari alifanya nini baada ya kutekwa nyara?

 49. Watu wabaya walifanya nini?

 50. Watu wabaya walimfunga kwa nini? _____



003

Grade 1

NAME SCHOOL DATE.....

ENVIRONMENTAL/RELIGIOUS ACTIVITIES

The weather is

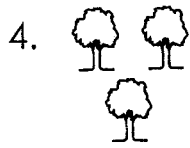
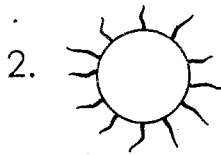
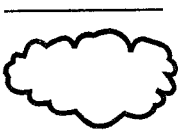

6. When going to school we wear school _____
(uniform, shorts, blouses)

7. We sing the national _____ while raising the flag.
(choir, anthem)

8. Who takes care of us at school?

(parents, teachers, ourselves)

9. We sleep in the _____
(kitchen, sitting room, bedroom)

10. The head of family is _____
(mother, father, son)

11. _____ keeps our bodies warm. **(hat, clothes, water)**

12. A cow gives us _____
(milk, honey, water)

13. Plates and cups are kept in the _____
(cupboard, table, box)

14. After sweeping we put rubbish in the _____
(bucket, dustbin, pocket)

15. Many trees growing together form a _____ **(farm, forest)**

Name the pictures.

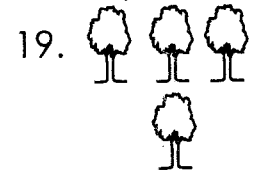

(forest, road, valley, hills)

Name the parts of this house.

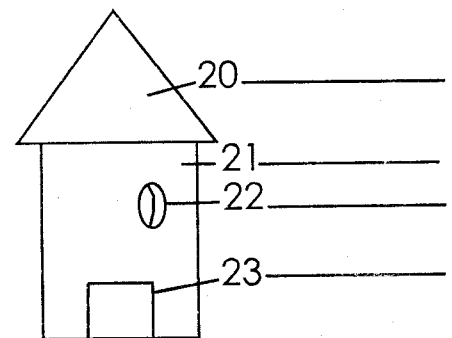

(roof, door, window, walls)

24. Rivers give us _____
(sand, water, soil)
25. A plant needs _____, 26. and _____
27, in order to grow.
(warmth, air, water, soil, house)
28. We get eggs from _____

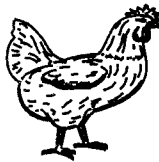

(hen, cat)

29. This is a _____

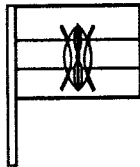

(flag, post)

30. Food is cooked in the _____
(kitchen, store)

C. R. E

31. The wife of Abraham was called _____
(Mary, Sarah, Isaac)
32. A deaf person cannot _____
(see, hear, smell)
33. Moses was given the _____
(Bible, commandments, story book)
34. _____ was killed by Cain.
(Abel, Eve, Adam)
35. Jacob had _____ sons.
(11, 12, 14)
36. Jesus had _____ disciples.
(11, 12, 10)

37. Abraham was the father of _____
(John, Isaac, Matthew)
38. The mother of Jesus was _____, while the father was 39 _____
(Joseph, John, Mary)
40. _____ helped the widows.
(Tabitha, Hannah, Paul)

Draw the following God's creation.

41.

Trees	Mountains

42.

43.

River	Lake

44.

45. This is a _____

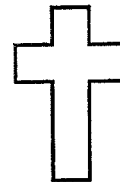

(cross, timber)

46. Christians worship in a _____
(church, mosque)
47. I should _____ my mother. (obey, kill, hate)
48. Sinners will go to _____
(hell, heaven)
49. The first man to be created was _____
(Adam, Eve, Judas)
50. Jesus was born in _____
(Bethlehem, Jerusalem)

Tusome Early Literacy Programme

Grade 1

Term 1

English Test

Name: _____

School: _____ Class: _____

Part A: Dictation.

Write the words as the teacher says them.

1. _____
2. _____
3. _____
4. _____
5. _____
6. _____
7. _____
8. _____
9. _____
10. _____

Part B: Fill in the blanks.

11. m ___ t
12. b ___ t
13. t ___ ble
14. s ___ t
15. writ ___

16. p ___ n

17. b ___ x

Part C: Make words using these letters.

18. s _____
19. c _____
20. d _____
21. b _____
22. a _____
23. z _____
24. f _____
25. t _____

Part D: Name the pictures.

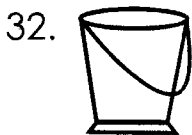
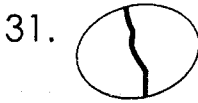
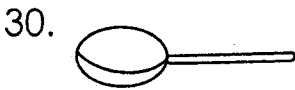
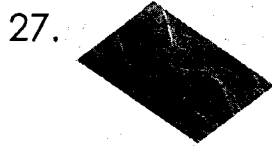
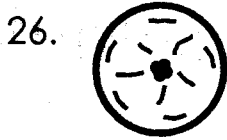

(bucket, pan, egg, envelope,
pen, towel, orange)

Part E: Write in capital letters.

33. box - _____
34. ruler - _____
35. children - _____
36. ball - _____
37. fan - _____
38. fun - _____
39. pan - _____
40. baby - _____

Part F: Arrange the following letters well.

41. amt - _____
42. etm - _____
43. yalp - _____
44. ma - _____
45. tis - _____
46. nda - _____

Part G: Name the parts of the head.

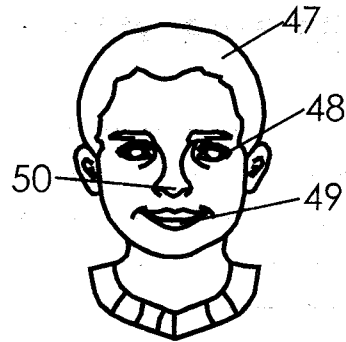

47. _____
48. _____
49. _____
50. _____



SOLUTION TRIAL EXAMS 2018

Grade 1

NAME SCHOOL DATE.....

READING

Read these words:

- | | | | |
|------------|------------|--------------|-------------|
| 1. leopard | 6. glasses | 11. magazine | 16. jug |
| 2. money | 7. rained | 12. sweet | 17. plane |
| 3. came | 8. weep | 13. lemon | 18. suck |
| 4. oxen | 9. boxes | 14. city | 19. airport |
| 5. spoon | 10. tiny | 15. blank | 20. cock |

Read these sentences:

21. My mother is a good cook.
22. We went to America by plane.
23. This is my shirt that was stolen.
24. Will you attend my birthday party?
25. What is your name?

KUSOMA

Soma maneno haya:

- | | | | |
|--------------|---------------|--------------|-------------|
| 1. kijana | 6. shuleni | 11. habari | 16. heshima |
| 2. meza | 7. daftari | 12. shikamoo | 17. duara |
| 3. chipukizi | 8. kaptula | 13. funguo | 18. tangazo |
| 4. mshauri | 9. maembe | 14. vuma | 19. mjomba |
| 5. kauli | 10. shangilia | 15. mganga | 20. fisi |

Soma sentensi hizi:

21. Mama huyu ndiye aliyenisaidia.
22. Sauti yangu imepotea.
23. Daktari alinidunga shindano kali.
24. Mzazi wangu haji leo.
25. Chakula hiki ni kitamu.